

VA-7010 Electric On/Off Actuator

Introduction

The VA-7010 electric on/off actuator provides a two-position (open-closed) control and can easily be mounted with a threaded coupling onto VG5000 forged brass valves and onto VG4000 cast bronze terminal unit valves (see pertinent bulletins).

A lever at the side of the actuator housing can be used to manually open a 2-way PDT0 valve, or the normally closed port of a 3-way valve.

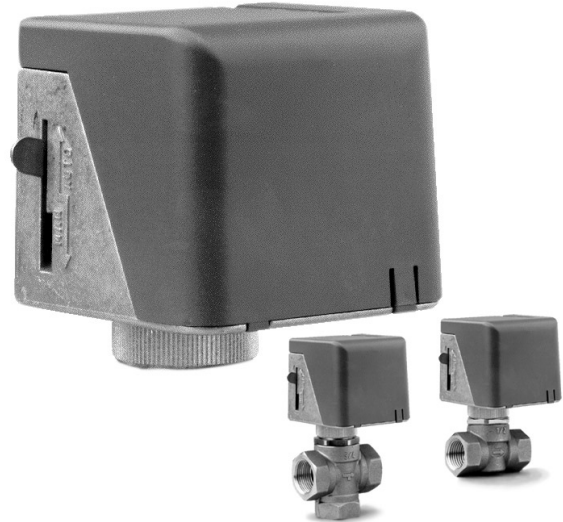

VA-7010 Actuator with VG5000 3-way (left) and 2-way (right) valves

Features and Benefits

- | | |
|---|--|
| <input type="checkbox"/> Low or Line voltage models available | Provides application flexibility |
| <input type="checkbox"/> AC stall type motor | Ensures quiet operation |
| <input type="checkbox"/> Manual lever | Allows manual position mode for servicing |
| <input type="checkbox"/> Flat profile design with small side clearance | Provides mounting close to flat surfaces; saves space |
| <input type="checkbox"/> Actuator can be mounted after valve body is installed | Simplifies installation in confined spaces; allows application flexibility |
| <input type="checkbox"/> Actuator can be rotated after mounting | Provides easier wiring by locating the wiring conduit entry in any direction |

Ordering data

	Supply voltage
VA-7010-8101	24 VAC
VA-7010-8103	230 VAC

UL approved models are available on request.

Actuator combinations

The VA-7010 series electric on/off actuators are specifically designed to be used with the VG5000 valve series. The ordering data for these valve bodies are as follows:

● VG4000 series

VG4 0 C All body types

● VG5000 series





VG5 0 C All body types

Please refer to the product bulletin "VG5000 Forged Brass Valves" and "VG4000 Cast Bronze Terminal Unit Valve" for complete ordering information.

Operation

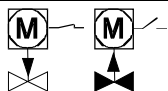
When energised, the actuator motor drives a sector gear and arm assembly, which pushes down axially on the valve stem against the force of the return spring. When the actuator is de-energised, the return spring in the valve brings back the valve to its normal position. (see "valve action summary")

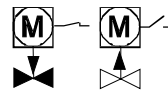
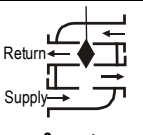
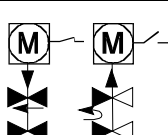
Valve Action Summary

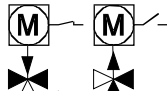
Code	Type	Stem movement / flow
		▶ = flow ▷ = no flow
VG42x0xC VG52x0xC	 2-way NO, PDTC*)	
VG44x0xC VG54x0xC	 2-way NC, PDT0*)	
VG55x0xC VB-5540-Sxxxx	 Return Supply 3-way + NO ByPass	
VG48x0xC VG58x0xC VB-5840-Sxxxx	 3-way, mixing	

*) PDTC = Push down to close
PDT0 = Push down to open

Manual Override

The VA-7010 actuator features a manual operating lever (shown in "Dimensions") for manually opening 2-way Push Down To Open valves or Normally Closed port of 3-way valves. The lever will not fully close 2-way Push Down To Close valves or the Normally Opened port of 3-way valves.

Mounting instructions

Observe the following recommendations when mounting the actuator:

- Make sure the actuator is easily accessible for the electrical connections.
- Make sure actuator is free of thermal insulation material.
- Leave at least 25 mm clearance above the actuator for mounting purposes. (See "Dimensions")

To mount the actuator on a VG5000 valve:

1. Place the threaded coupling over the valve stem on the bonnet.
2. Rotate the actuator to desired position and tighten the coupling securely by hand.

Note: Never use actuator as a mounting lever.

Wirings instructions

When wiring the actuator, please follow the instructions below:

- Before mounting, wiring or adjusting the actuator, make sure that the power supply has been disconnected to avoid possible harm to material or person.
- Make sure that the line power supply is in accordance with the power supply specified on the actuator.
- All wiring should conform to local codes and must be carried out by authorised personnel only.

WARNING

When servicing make sure that:

- The electrical supply to the actuator is switched off to avoid possible damage to the equipment, personal injury or shock.
- You do not touch or attempt to connect or disconnect wires when electric power is on.
- Do not open or repair, contact the nearest Johnson Controls commercial system wholesaler

Wirings diagrams

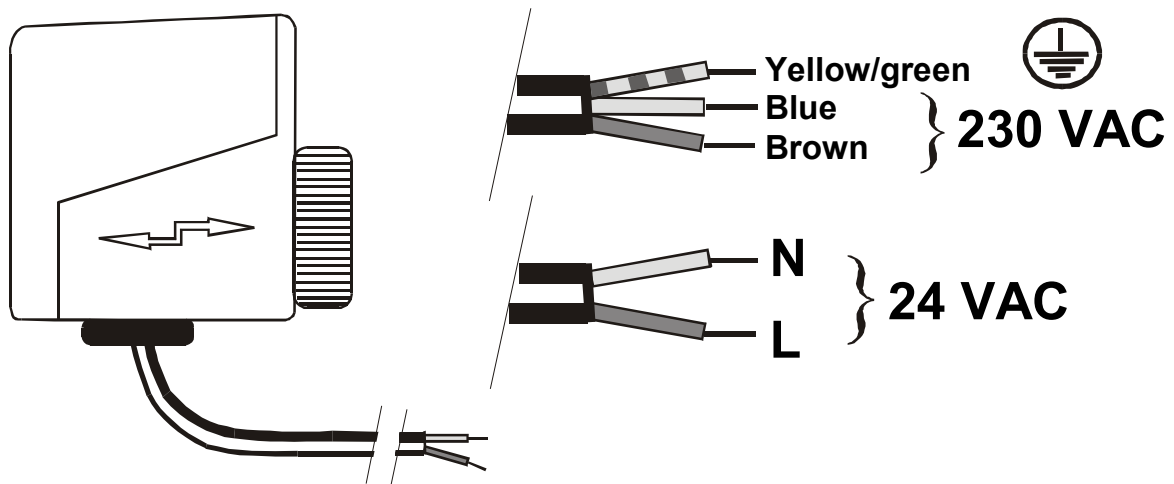

Dimensions (in mm)

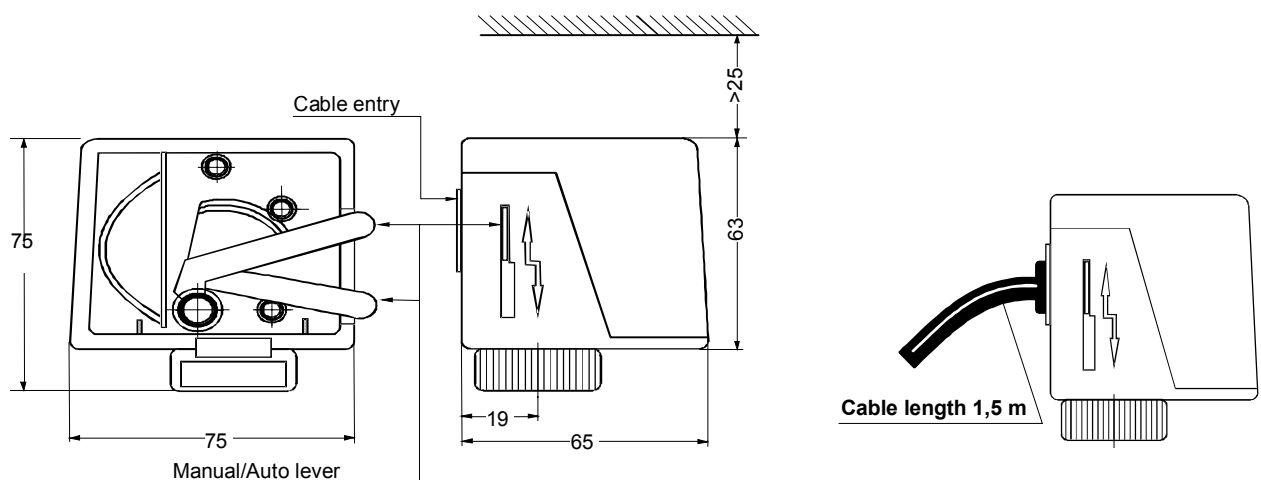

Specifications

Models	VA-7010-8101	VA-7010-8103
Type of motor	Synchronous stall	
Action	On / Off	
Supply voltage (50/60 Hz)	24 ±10% VAC	230 ±10% VAC
Power consumption	7 VA	
Minimum force	90 N (at minimum power supply and maximum temperature 50°C)	
Nominal stroke	3 mm (max. 5 mm)	
Full stroke time "On"	≈ 10 s	
Full stroke time "Off"	≈ 5 s	
Protection	IP40 (EN 60529), NEMA 1	
Connection to Valves	M28x1.5 for VG4000 and VG5000 series valves	
Ambient Operating condition	+2 to +50°C, non condensing	
Ambient Storage condition	-20 to +65°C, non condensing	
Shipping Weight	0.5 Kg	
Compliance	EMC directive (89 / 336 EEC): EN 50081-1 EN 50082-1 LVD directive (73 / 23 / EEC): EN 60335	

The performance specifications are nominal and conform to acceptable industry standards. For application at conditions beyond these specifications, consult the local Johnson Controls office. Johnson Controls, Inc. shall not be liable for damages resulting from misapplication or misuse of its products.



Johnson Controls International, Inc.

Headquarters: Milwaukee, WI, USA

European Headquarters: Westendhof 8, 45143 Essen, Germany

European Factories: Lomagna (Italy), Leeuwarden (The Netherlands), Essen (Germany)

This document is subject to change without notice